



QUEEN CITY PLASTICS, INC.

PVC CONDUIT & FITTINGS

Charlotte, NC 28241

Fort Mill, SC 29715

Schedule **80** 48 Radius (Plain End) – Fabricated

90° Elbows – Plain End

Part Number	Trade Size	Unit Qty.	Nominal DIA (D)	Min. Length (L)	Radius (R)	Radius Length
3451017	1"	U.C.R.	1.315	1-7/8"	48	86"
3451317	1-1/4"	U.C.R.	1.660	2"	48	86"
3451517	1-1/2"	U.C.R.	1.900	2"	48	87"
3452017	2"	100**	2.375	2"	48	88"
3452517	2-1/2"	100**	2.875	3"	48	88"
3453017	3"	48**	3.500	3-1/8"	48	89"
3453517	3-1/2"	48**	4.000	3-1/4"	48	91"
3454017	4"	42**	4.500	3-3/8"	48	92"
3455017	5"	30**	5.565	3-5/8"	48	94"
3456017	6"	30**	6.625	3-3/4"	48	96"

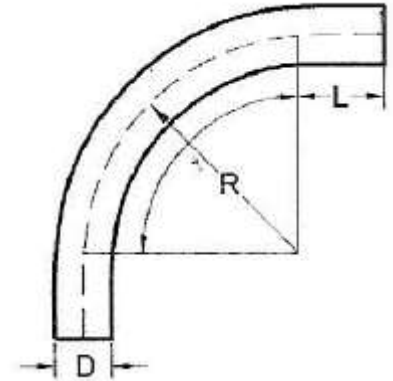

* Per G.L.

** Per Pallet

U.C.R.- Upon Customer Request

Conforms to UL651 and NEMA TC3
Material is Rigid PVC
Bend Tolerance is +/-2°

